

1146_0 Mechanical Drawing

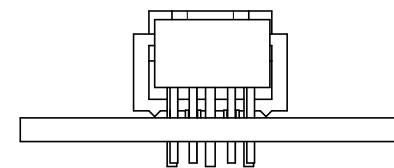
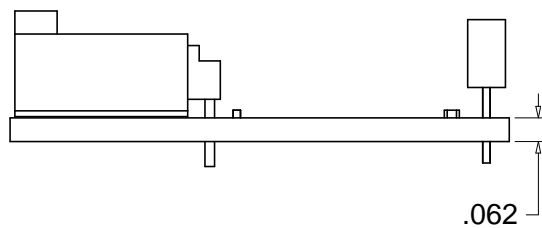
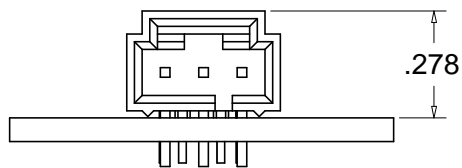
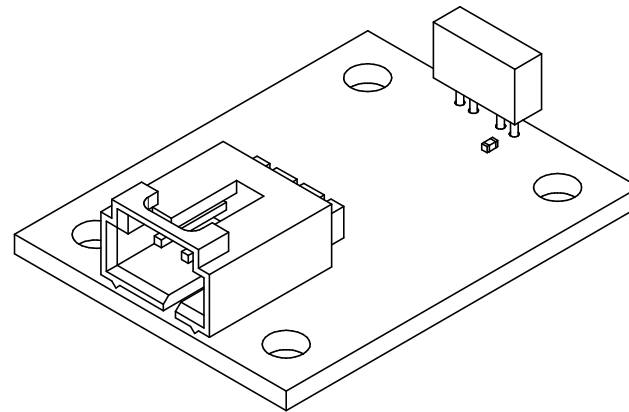
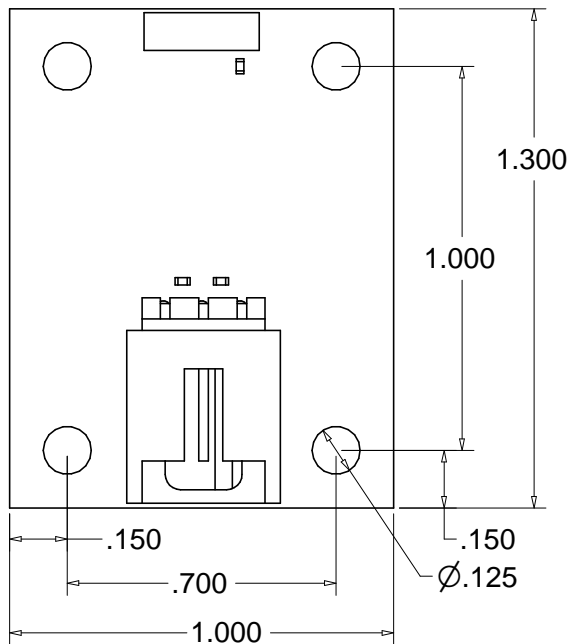

Scale 1:2
Units are in Inches