

REL1101_1 Mechanical Drawing

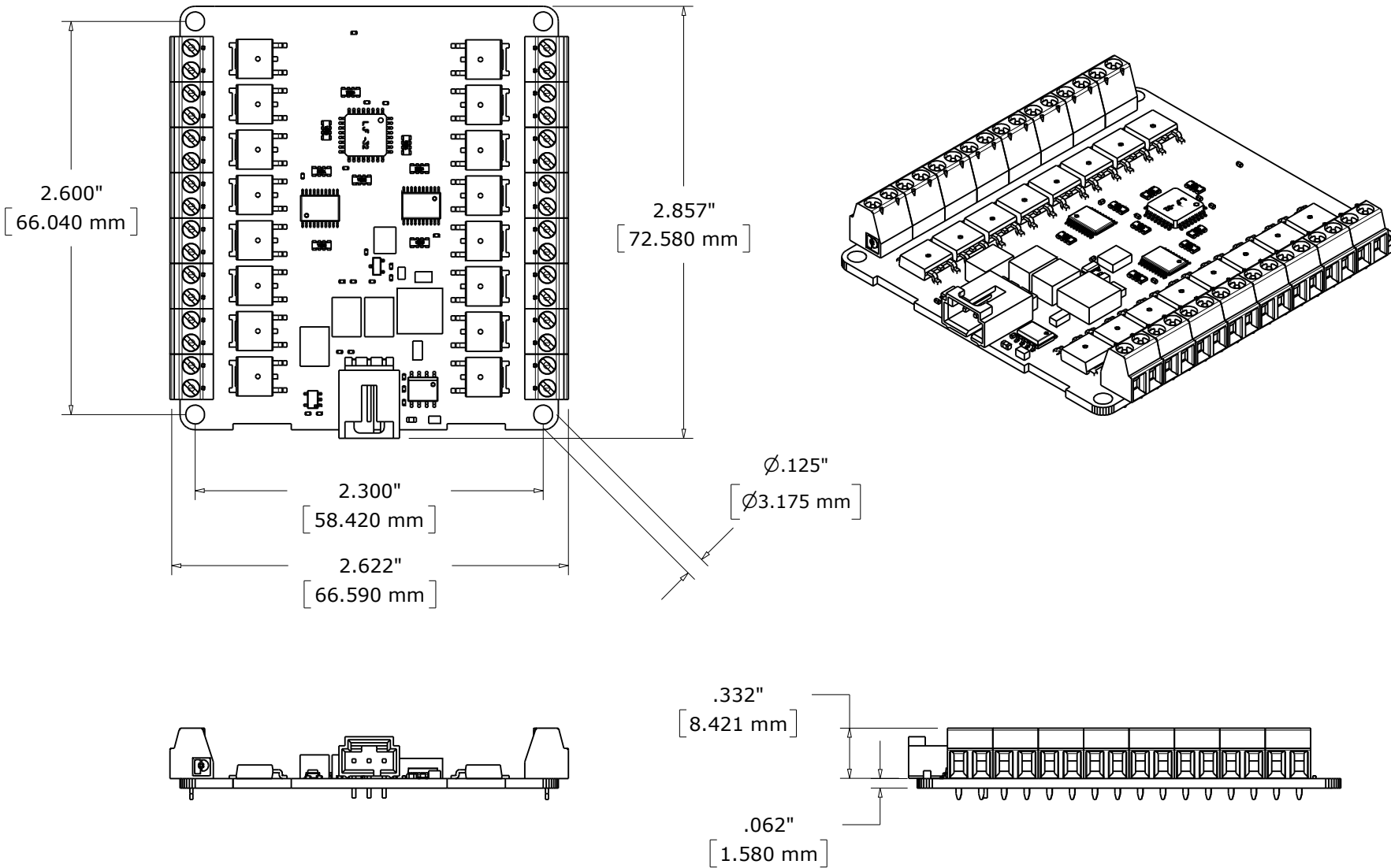

REL1101_1 Enclosure Mechanical Drawing

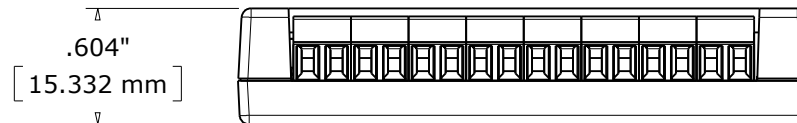
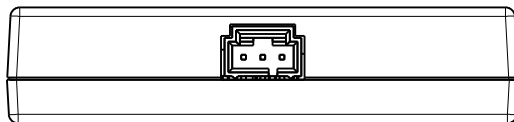
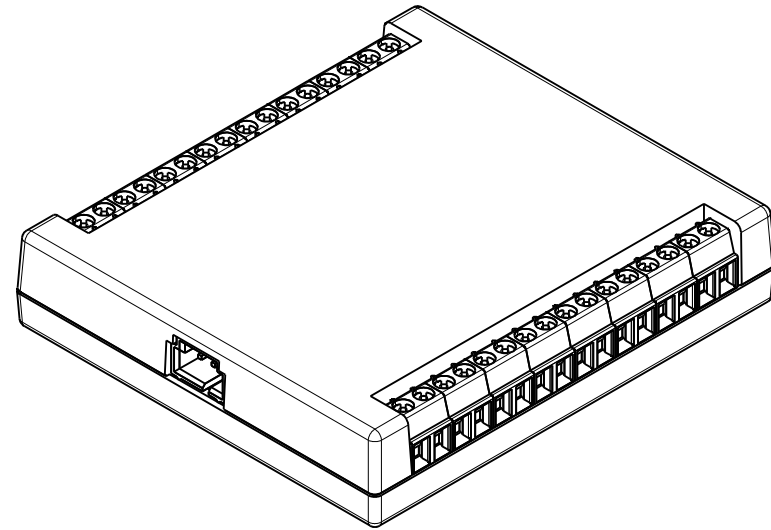
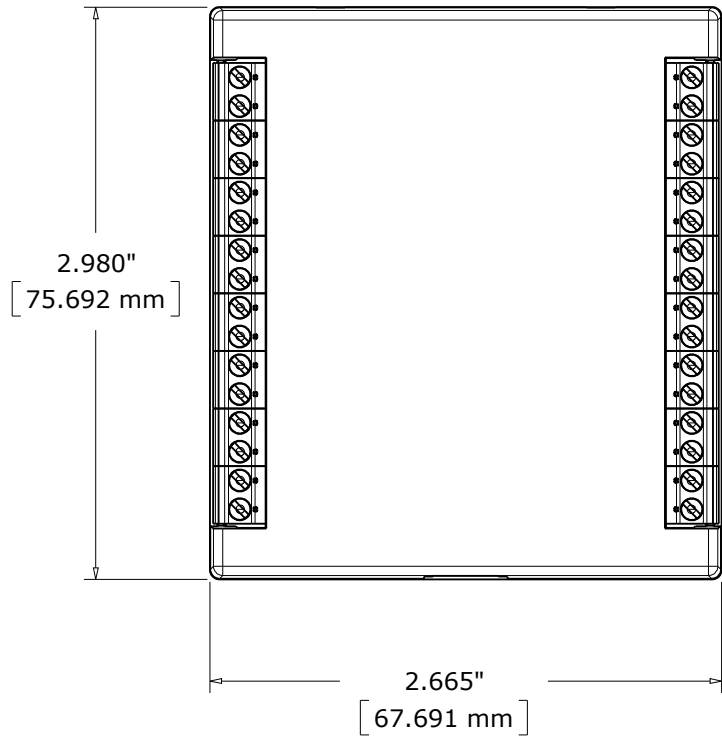

Mounting Dimensions

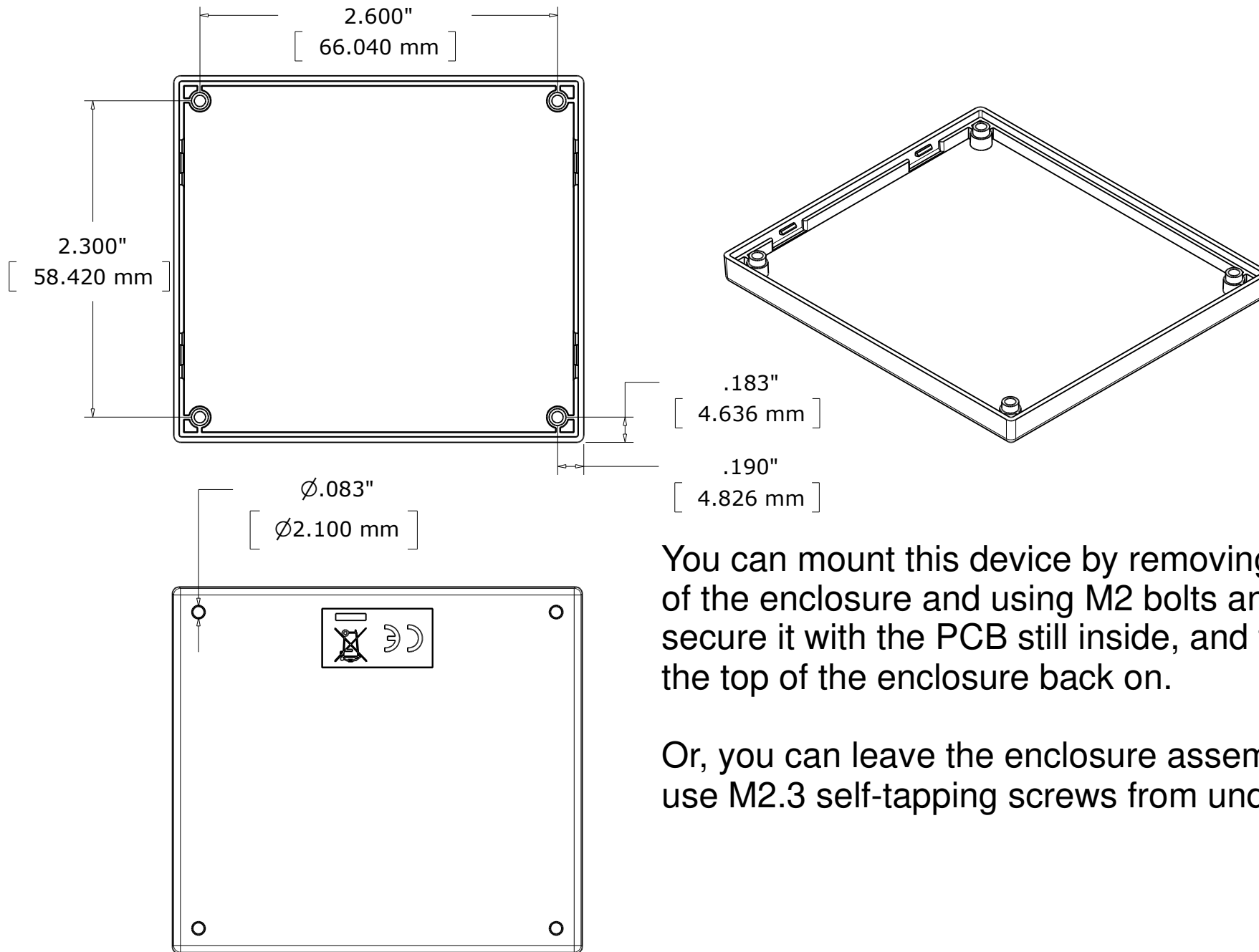

You can mount this device by removing the top half of the enclosure and using M2 bolts and nuts to secure it with the PCB still inside, and then snap the top of the enclosure back on.

Or, you can leave the enclosure assembled and use M2.3 self-tapping screws from underneath.